

INSTALLATION AND OPERATING INSTRUCTIONS FOR R+W FLEXIBLE GEAR COUPLINGS BZ / BZA



GENERAL INFORMATION



Please carefully and completely read the following installation, operation and maintenance procedures for the R+W flexible gear couplings. Failure to comply with these procedures may result in poor performance and/or the failure of the coupling. **Installation of the couplings should be performed by a qualified technician.**

SAFETY ALERT



Rotating couplings can be very dangerous. Proper guarding should be in place at all times and is the responsibility of the machine builder, user or operator. Do not approach or touch a coupling while it is rotating. Make sure that the machine is „locked out“ and cannot be accidentally started during installation or maintenance of the coupling.

TRANSPORT

R+W flexible gear couplings are delivered assembled without lubricant. The unpainted surfaces are treated with suitable corrosion inhibitors. On request others surface treatments can be supplied.

MANUFACTURER'S DECLARATION

According to EG guidelines for machinery 2006/42/EG Appendix IIB. In the sense of machine guidelines (MR) shaft couplings are no machines, but components for the installation in machines. Their putting into operation is subject to the fulfillment of all requirements of machine guidelines by or after integration in the final product.

HANDLING AND STORAGE

1. Before handling the couplings, check the weight of the components and their center of gravity in the catalogue and/or in the drawings.
2. Do not use equipment and procedures that can damage the couplings and their components.
3. Use the eye bolts to lift the couplings. Ensure that the device and tools used are suitable for the coupling. The safety regulations must be observed at all times.
4. Avoid any kind of collision during transport and storage.
5. Store the coupling covered and in a dry place. Avoid any direct contact with the floor.
6. If the storage time is more than six months, check the status of protection on the unpainted parts and apply a new protection film.

TAB. 1

SERIE	10	25	50	100	150	200	300	450	600
Quantity of grease [kg]	0,08	0,09	0,16	0,27	0,47	0,68	0,93	1,54	2,28
Tightening torque [Nm]	18	36	36	65	65	150	150	150	220
Distance between hole center [mm]	96	122	148	178	203	236	270	300	335
Number of holes	6	8	10	10	12	12	14	14	14
Hole diameter H8-d8	8/M8	10/M10	10/M10	12/M12	12/M12	16/M16	16/M16	16/M16	18/M18

SERIE	800	1500	2000	3000	4000	5000	7000	8000	10000
Quantity of grease [kg]	3,1	3,9	6,2	5	6	8	10	12	18
Tightening torque [Nm]	400	400	520	670	670	1250	1250	1250	2170
Distance between hole center [mm]	368	400	460	531	581	636	696	762	812
Number of holes	14	14	16	18	22	16	20	22	18
Hole diameter H8-d8	22/M22	22/M22	24/M24	25/M24	25/M24	32/M30	32/M30	32/M30	38/M36

SAFETY REGULATIONS

1. Couplings in operation are potentially dangerous elements, therefore adequate precautions must be taken to ensure that operation comply with the statutory safety requirements.
2. The installation, lubrication and maintenance should only be carried out by qualified and authorized personnel.
3. The operator must wear protective and tightfitting clothing. Do not wear clothing that could get entangled in the machine.
4. If any toxic chemical substances are used to clean the couplings, provide the operators with adequate protection.
5. The connection between the coupling and the machine must be disconnected when carrying out any work on the coupling.
6. During the operation, the allowable load should not be exceeded (torque, speed, working angles etc.).

Finish Bore

The coupling hub, when no tolerance is required, are delivered with pilot bores. These bores may not be concentric to the other turned diameters. The hub can be processed according to customer requirements. Before turning the bore, clean and remove all preservatives from the coupling hubs. Chuck the hub as shown on FIG. 1 and align the hub carefully by the outer diameter. The highest accuracy is to be achieved if run-outs are as near zero as possible and the bores must be perpendicular to the front end of the hub.

FIG. 1: BORE FINISHING

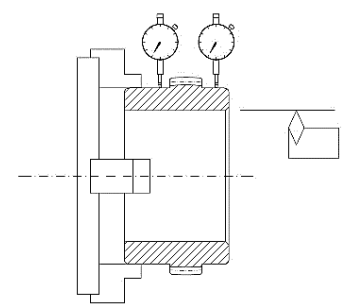

KEYED BORES

The finishing of cylindrical or taper bores and their keyways must be strictly complying with the standardization specifications for keyways. For keyed shafts, a light interference fit based on a nominal interference rate of 0.0005 of the shaft diameter is suggested. To obtain a tight interference fit, we suggest the tolerance H7 for the bore and m6-r6 for the shaft. Do not use a high interference fit for keyed coupling hubs.

It is recommended to use JS9 or P9 tolerance for the keyways. For standard keyways in standard hubs with nominal load conditions in heavy unidirectional duty and no-backlash fit, it is advisable not to exceed the following values of specific pressures:

Normally it is not necessary to grind the holes to meet the geometrical tolerances and surface quality. It can be finished just by turning. The machining of keyways with max bore diameter may create some ovalizations in the hub. It can be prevented by shrink fit since it is gripped radially from all sides. The keys must also be slightly forced on the hub and shaft.

- 1) for flex hubs made of hardened and tempered steel
 $P_{max} = 160 \text{ N/mm}^2$
- 2) for rigid hubs made of normalized steel
 $P_{max} = 100 \text{ N/mm}^2$

When using a transition fit or a clearance fit, it is recommended that the hub and the keyway be axially blocked, so to avoid that these components slip out of the shafts.

BORES FOR SHRINK FITTINGS

TAB. 2

SERIE		10*	25*	50*	100*	150	200
Handling screw size	M	M5	M6	M8	M10	M12	M12
Diameter for handling screws	C _f	61	73	91	115	132	154

SERIE		300	450	600	800	1500	2000
Handling screw size	M	M16	M16	M20	M20	M24	M24
Diameter for handling screws	C _f	180	204	220	240	268	316

* ONLY WHEN REQUESTED

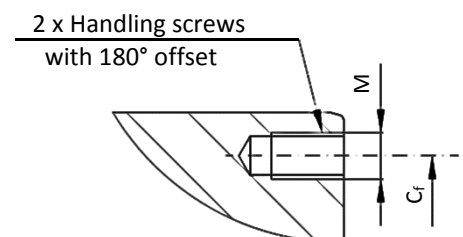

For shrink joints, the usual interference values should be between 1/1000 and 2.5 / 1000 of the nominal diameter. It can be achieved by fitting holes H6 and shaft s6-x6. It is important to note that the maximum applied stresses 80% of yield strength. Besides, in order to avoid problems of disassembly, the shrink pressure should never exceed the fit limit pressure of 300 MPa. If higher demands on accuracy and surface quality required and the hub needs being ground, contact the manufacturer, the engineer will check whether the tolerance and stresses in the hub meet the requirements according to the SKF standard. The max. torque must be at least four times the motor nominal torque, or 20% higher than the max possible overload.

Depending on the fit procedures, the friction coefficients must be between 0,12 and 0,18, never higher than 0,2. On the hubs, make some bores for SKF injector connections (special pumps for oil at 3500 bar useful to perform the shrink fit and the oil pressure removal), and some grooves for the oil spreading. Besides, arrange for a suitable number of screwed bores (refer to TAB. 2 for dimensions and position) for the connections of fitting and removal devices.

Remember that, for various reasons, the real removal axial forces may be remarkably higher than the theoretic calculated ones.

PREPARATION FOR ASSEMBLY

FIG. 2: List of components

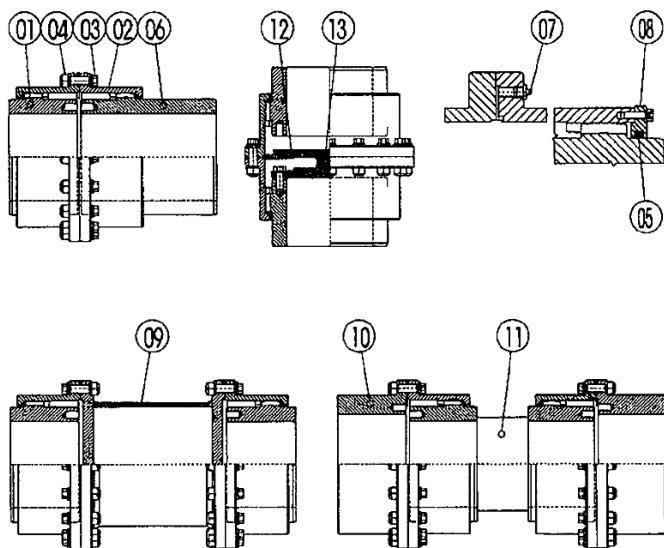

01	Standard hub
02	Flange sleeve
03	Set screw
04	Hexagon self-locking nut
05	Seal
06	Long hub
07	Grease nipple or plug
08	Removable side flange
09	Tubular spacer
10	Rigid hub
11	Intermediate shaft
12	Intermediate disc
13	Button disc

1. The operations of inspection and assembly must only be carried out by qualified and skilled personnel.
2. Before proceeding with installation, make sure the operation data (nominal and max torque, working misalignment etc.), as well as the dimensional data and tolerances (DBSE, shaft and keyway diameters and lengths, end floats, strokes etc.) shown in the coupling overview drawing, do correspond to the plant requirements and adaptability.
3. For couplings with particularly long spacers and rotation speed > 300 rpm, check that the max rotation speed. It should not exceed the 80% of the critical bending speed.
4. Unpack the coupling and check its conservation.
5. Clean the unpainted surface.
6. Carefully clean the bores of the coupling hubs and the shaft ends. The surfaces must be clean, dry and free of grease.



NEVER USE CORROSIVE CLEANERS!

7. If the holes should be reworked, observe geometrical tolerances.



NEVER EXCEED THE ALLOWABLE LOAD AND APPROVED PARAMETER LIMITS!

HUB FITTING

1. BEFORE PROCEEDING WITH THE HUB FITTING, MAKE SURE THE FLANGE SLEEVES OR THE REMOVABLE SIDE FLANGES ARE PROPERLY POSITIONED ON THE SHAFTS.

Uniformly heat the hubs, either in air furnace or in oil bath, both thermostatically controlled, or by suitable induction systems. It is also possible to heat the hubs of limited dimensions by a free flame, provided that you take care of heating uniformly the whole surface and do not generate overheating. Check the temperature frequently so not to exceed the max allowed value. When heating, do not direct the flame to the gear teeth. Avoid any excessive oxidation, slightly preheat the outer surface of the hub. Work under the maximum safe conditions and keep away from flammable materials or substances.

2. HUB KEY-FITTING

For keyed shafts, a light interference fit based on a nominal interference rate of 0.0005 of the shaft diameter is suggested. To obtain a tight interference fit, we suggest the tolerance H7 for the bore and m6-r6 for the shaft. Do not use a high interference fit for keyed coupling hubs.



Heating temperatures are to be comprised between 110-130°C. Never exceed 180°C!

3. KEYLESS HUB SHRINK-FITTING

For shrink joints, the usual interference values should be between 1/1000 and 2.5 / 1000 of the nominal diameter. It can be achieved by fitting holes H6 and shaft s6-x6.

If higher demands on accuracy and surface quality required and the hub needs being ground, contact the manufacturer, the engineer will check whether the tolerance and stresses in the hub meet the requirements according to the SKF standard.



Heating temperatures are to be comprised between 180 and 250°C. Never exceed 320°C!

Once the hubs are heated and after wearing suitable thermal insulated gloves, clear the hole seats with a proper cleaning paper and measure the entity expansions. Then lubricate hole, shaft and any possible key surface by non-additivated pure mineral oil. Once verified the accurate cleanness of shaft, hub and fitting holes, proceed with shrink fitting

Check that the flange sleeves or the removable side flanges have integral seals and are correctly inserted in the seats. Avoid any contact between the hub hot surfaces and the seal; assemble the flange sleeves and the removable side flanges on the hubs only when the hub temperature is lower than 60°C.

ASSEMBLY

TAB. 3

SERIE		10	25	50	100	150	200	300	450	600	800	1500	2000
C _L	[mm]	24	29	38	44	57	66	76	86	100	114	124	146
F	[mm]	69	85	107	133	152	178	209	234	254	279	305	355
C _A	[mm]	55	62	74	86	100	115	130	145	160	175	190	220
H	[mm]	1,5±0,5	1,5±0,5	1,5±0,5	1,5±0,5	1,5±0,5	1,5±0,5	1,5±0,5	1,5±0,5	1,5±0,5	1,5±0,5	1,5±0,5	1,5±0,5

1. Position the machines so that the axial distance between the hubs is according to the D.B.S.E in the catalogue or in the drawings. Obviously, this dimension must be proportionate to any possible thermal expansion or axial movement/stroke of the connected shafts. Moreover, in order to enable the subsequent adjustment of the coupling, the flange sleeves shall be allowed to move back as to show the necessary part of the hub. The necessary minimum movement is called "c_A" in TAB. 3 or in the drawings. To make assembly easier, you should be able to move the flange sleeves back as far as they withdraw from the gear teeth. If there is not enough space on the side, we recommend you to order the couplings with removable side flanges. To remove the gear couplings without moving the connected machines, then you should order the couplings with intermediate spacer.

It is advisable that the total residual misalignment between the two half couplings is contained in a value very close to 1/1000 of the distance between the gear teeth of the coupling (C_L). For standard applications, the maximum allowed deviation of the max dynamic angles is prescribed for each type of coupling. This must always be lower than the allowed working angle complying with the max rotation speed in operation (see K_v diagrams in FIG. 3). Secure the machines to their foundations and frames, by tightening all the locking bolts and nuts. After this operation, check once more the alignment of the half couplings

$$n_{\max,\alpha} = n_{\max} \cdot K_v$$

FIG. 3: Kv Diagram

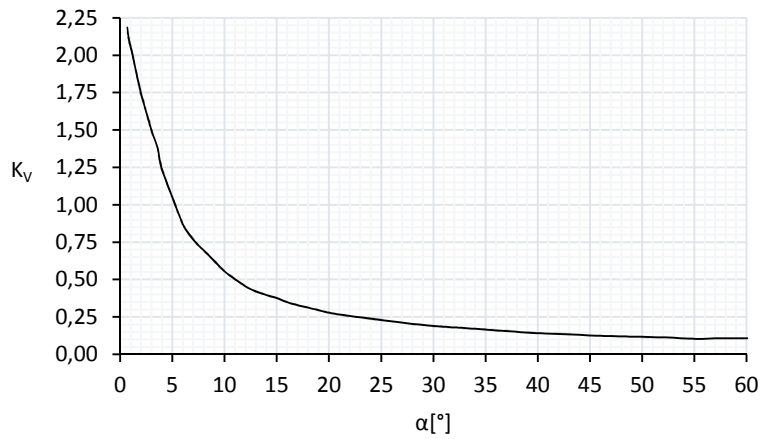

2. Assemble the flange sleeves and the side flanges on the gear hubs carefully and avoid damaging the seals. If the seal is damaged (cut or burnt), replace it immediately, then fill the coupling with grease.
3. Close the gear couplings and assemble all their components and devices. To assure a perfect fitting, it is advisable spreading a slight mastic film on the flanges before closing them. Make sure the coupling is always concentric when assembled. The assembly marks show the correct alignment and orientation of the hubs.
4. Screw the main bolts of flange with the torque in TAB. 4, then tighten all the remaining screws carefully.
5. Balanced assemblies are match marked. For balanced couplings, all the fitted bolts and nuts are balanced and must be in their original position. The bolt sets cannot be mixed with other couplings.
6. Using a grease press, press grease through the lubricating nipple or the conical plugs. Do not exceed a lubricating pressure of 15 bars. Make sure that the floating part of the gear coupling (gear hubs and spacers) is able to move axially by H (see TAB 3).

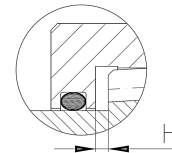

7. Check all bolts, nuts, screws, and other fasteners; tighten, if required.
8. Before starting the machines, place proper safety protections around the coupling.
9. Coupling should be checked and tested for its performance once every 6 months to verify that the alignment and the components are in conformity with the design parameter.

TAB. 4

SERIE	10	25	50	100	150	200	300	450	600	800	1500	2000
Seal	OR-68	OR-85	OR-107	OR-133	OR-152	OR-177	OR-209	OR-234	OR-253	OR-279	OR-304	OR-355
Tightening torque [Nm]	18	36	36	65	65	150	150	150	220	400	400	520

ALIGNMENT



CORRECT ALIGNMENT IS ESSENTIAL TO ENSURE A LONG OPERATING LIFETIME

The static alignment must consider the deviations caused during operation by the load and temperatures. The alignment can be easily measured with a laser alignment tool. In this case, the operator should follow the instructions to use the equipment.

If such an equipment is not available, you can use a precision gauge or an internal micrometer with extension and follow the following steps to check the alignment.

Check the parallelism ΔA and coaxial alignment ΔP as follows:

1. The angular misalignment can be determined, in accordance with the tables, from the measurements of the parallelism on the reference surfaces of the hubs. For this purpose, insert the precision gauge between the end of the two hubs, perform a 360° test to identify the min and max distance between the hubs. Then perform a measurement of 4 points at 90°, like  in FIG. 4. The max difference between two measurements is ΔA .







To determine the coaxial alignment between the reference diameter of the two hubs, set the precision gauge to the reference diameter of one of the two hubs (like  in FIG.02). Determine the runout of the second hub. The max difference is ΔP .

FIG. 4: Determination of the misalignment

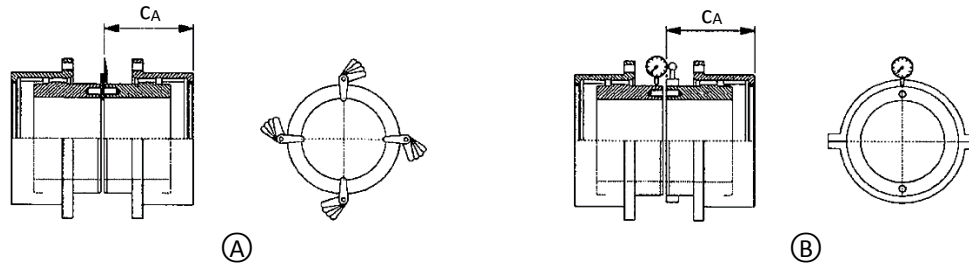

2. For couplings with spacer or with floating shaft, check the alignment between the hubs reference surfaces by using an inside micrometer like  or a precision gauge like  or  in FIG.05. The max difference between two measurements is ΔA .

Couplings with spacer having a long distance between the gear teeth. Therefore allow this for higher misalignment than standard couplings.

The coaxial alignment is measured by a precision gauge, positioned like ,  or  in FIG. 5. The max difference is ΔP

Distance of extensions C_1 , Hub outer diameter F , necessary distance for the alignment c_A and axial stroke of the sleeves H see TAB. 3.

FIG. 5: Determination of the misalignment

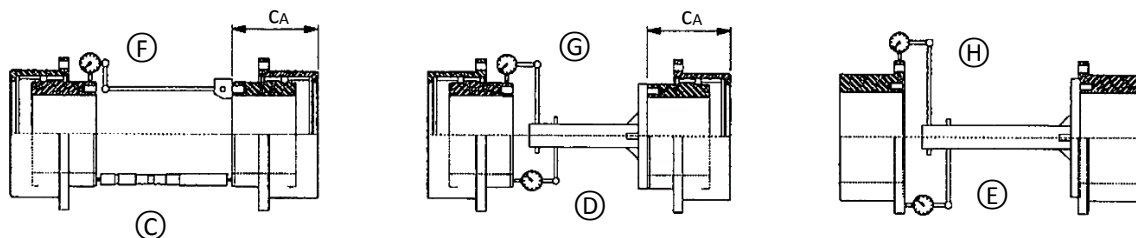

LUBRICATION



PROPER LUBRICATION IS ESSENTIAL TO LONG LIFE-TIME OF A GEAR COUPLING.

1. After the hub shrink fitting and the positioning of the gear sleeves and side flanges, fill with recommended grease until an excess appears at an open lube hole. After closing the gear coupling, spread a slight mastic film on the flange connection surfaces.
2. Close the coupling and tighten all the screws with the recommended torques (see TAB. 4 or the drawings), then complete lubrication through all the grease nipples and/or all the plugs (2 each half coupling).
3. To fill the coupling chambers, remove the plug or the grease nipple of each half coupling. Connect the pump to the other grease nipple or to the connection hole and pump grease to the coupling completely, until the excess of grease comes out of the open holes. For horizontal couplings, to be sure the chambers are filled with grease, pump it from the vertical bore (max 45°) downwards and wait until it comes out from the opposite hole upwards. For the operation, use pumps with pressure controls. Never put the inner parts of the coupling under pressure.

4. Once lubrication is performed, make sure the coupling is completely filled with grease, then insert the plugs and/or the grease nipples carefully and check their tightening.
5. At the beginning, relubricate the couplings at regular intervals, every 3-4 months. This interval is suggested in case of integral seals, industrial applications and average duty, non-corrosive environments, working temperatures between 0 and 60°C. Shouldn't the seals assure a perfect tightness, make necessary refilling to keep the coupling constantly full of grease and replace the seals. If no disturbances are detected after one year, the check intervals can be extended up to 6 months. For different conditions, time intervals between lubrications can be extended, but never longer than 12 months or 36 months. When lubricating, you must always have a certain grease turnover. When using multipurpose grease, you'll have to renew about ¼ of the old grease every three months. To let the old grease out, remove a plug or a grease nipple at 180° from the new grease filling point and pump the new grease until the worn-out grease comes out of the breather. The worn-out grease shall have to be collected and kept in suitable containers for disposal.

At the end of this operation, reassemble the plugs and/or the grease nipples, checking that they are properly tightened.
6. When lubricating, always check the tangential clearance on the gear teeth - if this is feasible and the dimensions allow it - and check that the floating item of the coupling is axially free. If no movement is allowed or if the tangential clearance is excessive, open the coupling and examine its gear teeth.
7. When using multipurpose grease, you have to replace it completely every 8000 hours or max every two years. You shall have to open the coupling, clean the flange surfaces, remove the old grease completely, clean any interstice, check the gear tooth condition and perform steps 1 to 4. Never use contaminated grease or grease inadequate to the operating conditions. To open the two flanges of the sleeves do not use tools that may damage the seal surfaces
8. To lubricate standard couplings, use new lithium soap or complex lithium grease (not older than three years), composed of paraffinic mineral oils or high viscosity synthetic oils, having a max H₂O content of 0,3% and EP additivated. The flash point must be > 145°C, and grease must be centrifugation resistant, antioxidant, water-repellent, anticorrosive and antihygroscopic. For heavy loaded or high load capacity couplings, we recommend employing special EP grease containing high viscosity oil > 630 cSt at 40°C, micronized and MoS additivated. The minimum features of EP multipurpose grease usable to lubricate gear couplings must be like those shown in TAB. 5.

TAB. 5

Thickener	Lithium complex
NLGI Grade	2
Application range of temperature	- 30°C + 160°C
Penetration at 25°C	265 - 295 (0.1 mm)
Anti-rust performance	Ja
Dropping point	> 260°C
Viscosity at 40°C	340 mm ² /s (cSt)



FOR ALL THE CONDITIONS MENTIONED BELOW, SELECT THE SUITABLE GREASE, BY DIRECTLY CONTACTING THE LUBRICANT PRODUCERS, THEN SUBMIT THE FEATURES OF THE SELECTED GREASE TO MANUFACTURER FOR ACCEPTANCE:

- Extreme duty conditions
- Very high, pulsating, reversible loads
- Extreme or highly variable rotation speed
- Frequent axial movements
- Extreme operating temperatures
- Extrem hohe Drehzahlen
- "LONG-LIFE" Schmierung
- Presence of parasitic currents or vibrations



NEVER MIX DIFFERENT TYPES AND/OR DIFFERENT BRANDS OF GREASE. THEY MAY BE INCOMPATIBLE AND MAY LOSE THEIR LUBRICATING FEATURES. UNLESS OTHERWISE INSTRUCTED, NEVER USE OIL TO LUBRICATE GEAR COUPLINGS.